

# ALTERNATOR INSTALLATION AND OPERATION MANUAL

**BALMAR**<sup>®</sup>  
WWW.BALMAR.NET  
**DC CHARGING SOLUTIONS**

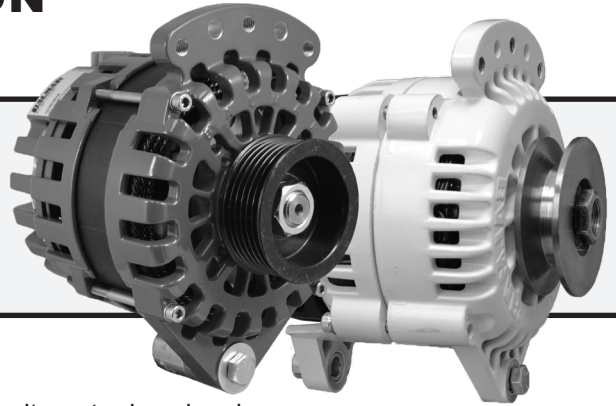

## INTRODUCTION

Thank you for choosing a Balmar high-output alternator. This alternator is uniquely designed to provide the finest performance and durability for your installation.

When used with a Balmar multi-stage regulator, your alternator can provide even greater efficiency when charging deep-cycle flooded, standard flooded, gel, AGM, LiFePO<sub>4</sub>, Optima and other marine battery technologies. When preset for your battery type, the smart regulator will guide your alternator through a charging program that's tailored to provide your batteries with the best care possible.

## CONTENTS

<b>SAFETY CONSIDERATIONS</b> .....	1
<b>ALTERNATOR MOUNTING STYLES</b> .....	2
<b>ALTERNATOR INSTALLATION ISSUES</b> .....	2
<b>SIZING BATTERY CABLES</b> .....	3
<b>BELT SIZE REQUIREMENTS</b> .....	3
<b>BELT TENSION</b> .....	3
<b>FAN ROTATION</b> .....	3
<b>GROUNDING</b> .....	3
<b>PULLEYS</b> .....	4
<b>ALTERNATOR HEAT</b> .....	4
<b>FUSING</b> .....	4
<b>ALTERNATOR-TO-BATTERY RATIOS</b> .....	4
<b>MULTIPLE BANK CHARGING OPTIONS</b> .....	5
<b>BATTERY SWITCHES</b> .....	5
<b>BATTERY COMBINERS/SOLENOIDS</b> .....	5
<b>BATTERY ISOLATOR</b> .....	5
<b>DIGITAL DUO CHARGE</b> .....	6
<b>TWO ALTERNATORS-SINGLE ENGINE</b> .....	6
<b>TWIN ENGINE ISSUES</b> .....	7
<b>CENTERFIELDER</b> .....	7
<b>INSTALLATIONS BY ALTERNATOR</b> .....	8
<b>6-SERIES ALTERNATORS</b> .....	8-9
<b>XT-SERIES ALTERNATORS</b> .....	10
<b>94 &amp; 94LY-SERIES ALTERNATORS</b> .....	13
<b>95-SERIES ALTERNATORS</b> .....	14
<b>97EHD-SERIES ALTERNATORS</b> .....	15
<b>97XD- SERIES ALTERNATORS</b> .....	16
<b>98-SERIES ALTERNATORS</b> .....	17
<b>SYSTEM TROUBLESHOOTING</b> .....	18
<b>WARRANTY</b> .....	24

## SAFETY CONSIDERATIONS

Before installing your new alternator, please take a moment to consider the following guidelines for safe alternator installation and operation. Failure to follow these guidelines could result in injury or damage to your vessel's electrical system.

1. Always disconnect your batteries and turn your battery switches to their "OFF" positions prior to installing your alternator.
2. Remove any loose fitting clothing or jewelry which could become entangled in your motor or other machinery.
3. Wear ANSI-approved safety glasses or eye wear.
4. Ensure that the engine has cooled sufficiently before beginning installation.
5. DO NOT install your high-output alternator without ensuring that system wiring is sufficient to handle increased amperage loads.
6. Be sure that your work area is properly ventilated and that no fuels or solvents are present in and around your work area.
7. DO NOT operate your charging system without proper fusing. Failure to do so could result in severe injury and/or damage or loss of your vessel. DON'T take chances with fusing.
8. DO NOT attempt installation while using alcohol or medications which could impair your judgement or reaction time.
9. Use the right tool for the job. Use of improper tools could result in damage or injury.
10. Take time to read the manual. Equipment damage and possible injury may result from an incomplete understanding of the proper installation and use of the alternator.

**CAUTION:** The following instructions are intended for use by experienced marine electrical installers. If you are not sufficiently experienced with marine electrical systems, we recommend a qualified electrician be used for installation.

## ALTERNATOR MOUNTING STYLES

Due to the large number of engine makers and engine models, Balmar cannot guarantee a drop-in replacement for every application. We recommend installing the alternator model that most closely matches your existing alternator. Your installer may have to adapt the basic mounts to fit your needs. The majority of marine engines are equipped with one of five alternator mounting styles. The following describes which alternator represents each specific mounting style:

(A) 621 & AT/XT-SF-Series (1" Single Foot): Replaces most domestic styles using a single 1" mounting foot (eg., Motorola, Prestolite). 621 is used without included spacer.

(B) 621 & XT-SF-Series (2" Single Foot): Replaces most domestic styles using a single 2" mounting foot (eg., Delco). 621 is used with included spacer.

(C) 60 & AT/XT-DF-Series (Dual Foot w/3.15" between mounting feet): Replaces most small case alternators using a saddle style mount (eg., Hitachi, Lucas, Mitsubishi).

(D) 95-Series (Dual "J-180" Foot w/4" between mounting feet): See case dimensions on our website at [www.balmar.net](http://www.balmar.net) to verify if your engine compartment can accommodate the large case alternator.

(E) 97, XT-DF4, 97XD, 97EHD & 98-Series (Dual "J-180" Foot w/4" between feet): Extra large case. See case dimensions at [www.balmar.net](http://www.balmar.net) to determine if your engine can accommodate an extra-large case alternator.

(E) XT Alternators are available in Vortec (GM) mount with Internal regulators. See SUP-0256 XT-IR Alternator Installation and Operation Manual

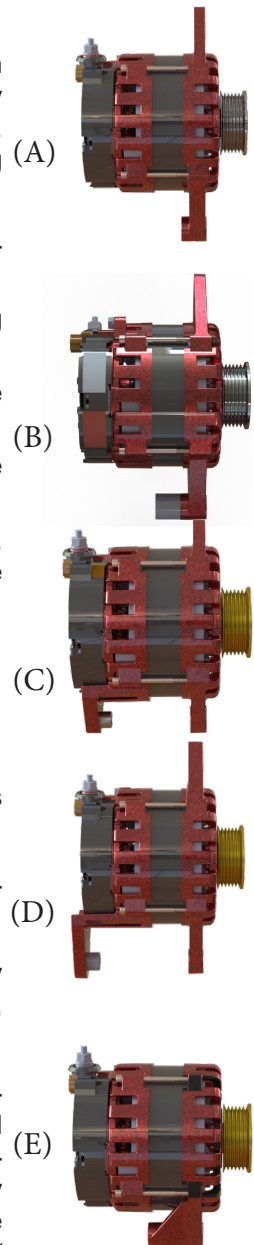

## ALTERNATOR INSTALLATION ISSUES

1. While each alternator series may have some varied installation issues, the following guidelines should be considered when installing any Balmar alternator:
2. Ensure, prior to installation, that the Balmar replacement alternator features a compatible mounting configuration to the alternator being replaced. See information above.
3. Ensure that the replacement alternator is adequately sized to meet the demands of your battery banks. As a rule of thumb, the alternator should be rated at 25-40% of your house battery capacity, depending on the battery chemistry.
4. Ensure that the belt or belts driving the alternator are capable of handling the alternator's horsepower load. As a rule, a single 3/8" belt is capable of supporting up to 80 amps@12 volts, and a single 1/2" belt can support 100-amp@12-volts. Dual belts will typically support alternator outputs of up to 300+ amps/12 volts. Driving an alternator on an undersized belt will substantially increase the risk of belt slippage and premature belt failure. All 24-volt Balmar alternators require a minimum of dual 1/2" belts for optimal performance. *Balmar offers a wide selection of AltMount serpentine pulley kits for marine diesel engines. Visit the Balmar website for more information and application charts.*
5. Balmar alternators are designed to be used in conjunction with external P-type regulators. We recommend a Balmar multi-stage regulator for maximum charging performance. Certain Balmar alternators designated as Smart Ready® feature a single-stage internal regulator. Those alternators can be controlled by either the internal, or an external voltage regulator. Please note that the internal regulator must be disabled when an external regulator is being used.
6. All Balmar alternators except Case-Ground versions are equipped with isolated grounding terminals. Isolated ground alternator installations MUST include a dedicated cable connecting the alternator ground terminal to system ground. The ground cable must be equal in size to the alternator's positive output cable, and must meet the cable gauge requirements outlined in the cable size chart shown on Page 3.
7. Belt tension is a critical aspect of alternator performance. Monitor belt tension after every charge cycle for the first several weeks of engine operation. We recommend a belt tensioning gauge for accurate deflection measurement. Make belt tension monitoring and adjustment a part of regular maintenance.

## SIZING BATTERY CABLES

Battery cable size must meet the increased output capacity of your new alternator. The easiest method for determining the best cable size for your system is to compare your new alternator's rated amperage output and the ROUND TRIP length of the cable running from the alternator to the battery being charged, and back to the alternator via ground to the chart at right.

Cable length requirements may also be calculated with the formula  $CM=K \times I \times L/E$  (whereas CM represents the circular mil area of the conductor, K represents the mil-foot resistance of copper, I represents current, and L represents the length, in feet, of the round-trip cable run and E represents voltage drop in volts). When using this equation, a K constant of 10.75 indicates copper's mil-foot resistance and voltage drop should be calculated at 3% (0.36V for 12V, 0.72V for 24V).

## BELT SIZE REQUIREMENTS

Your Balmar alternator demands more horsepower than your standard OEM alternator. This additional load may require that you replace the standard drive belt with a heavier-duty unit. Many aftermarket belt manufacturers supply premium quality belts, designed specifically for heavy-duty marine and industrial applications. Among these are the Green Stripe belt by Gates and the Top Cog belt from Dayco. In addition, many auto parts suppliers, such as NAPA, carry extra heavy-duty belts designed to support larger horsepower loads.

As a rule-of-thumb, we recommend a minimum 3/8" belt (measured across the back of the belt) for our 70-amp (12-volt) alternators. Minimum belt width for 100-amp alternators is 1/2". Any 12-volt alternator larger than 100-amps or 24-volt Balmar alternator will require dual belts or a flat, multi-groove belt for optimal performance, as well as acceptable belt life.

## BELT TENSION

Under or over-tensioned belts can result in belt slippage, premature belt wear, alternator overheating and belt failure. Typically, belt deflection should be between 1/4" and 3/8" when you push your thumb down on the back of the belt at mid-span between pulleys. For more precise tensioning adjustment, use a commonly available tensioning gauge. The use of a belt tensioner, or pulley jack, makes it easier to adjust the belt tension by using mechanical means to push the crank pulley and the alternator pulley apart. One such device, sold by MSC Industrial Supply 1-800-645-7270 (Part. # 35438209) is designed to provide "hands-free" tensioning for V-Belts.

## FAN ROTATION

6-Series, XT-Series and the 97EHD alternators feature single or dual internal cooling fans, and are designed to provide maximum cooling protection when rotated in a clockwise rotation (looking at the front of the alternator when mounted on the engine). Using these alternators in reverse (counter-clockwise) rotation applications may affect alternator cooling and performance. Large case 94, 95, 97XD, and 98-Series alternators feature bi-directional fans, which are equally effective in normal or reverse rotation applications.

## GROUNDING

Alternator models designated as Isolated Ground (IG) feature an independent ground terminal that's isolated from the alternator case. Isolated Ground alternators are used in applications where the engine is not desired to be a part of the grounding system. This is commonplace in steel or aluminum hull boats, or with engines that depend on sophisticated electronic ignition systems. In other applications, isolated grounding simply ensures that the alternator is sufficiently connected to system ground. The alternator's ground cable should be the same size as the alternator's positive output cable. Some case-ground alternators provide an auxiliary ground post to provide a convenient location to attach the battery ground cable.

Length/Ft.	5	10	15	20	25	30	40	50	75
<b>Amps</b>									
<b>75</b>	8	6	4	2	2	1	1/0	2/0	4/0
<b>100</b>	8	4	2	2	1	3/0	3/0	4/0	
<b>125</b>	6	4	2	1	1/0	3/0	4/0		
<b>150</b>	6	2	1	1/0	2/0	3/0	4/0		
<b>175</b>	6	2	1	1/0	2/0	3/0	4/0		
<b>200</b>	4	2	1/0	2/0	3/0	4/0			
<b>225</b>	4	1	1/0	2/0	3/0	4/0			
<b>250</b>	2	1	2/0	3/0	4/0				
<b>275</b>	2	1	2/0	3/0	4/0				
<b>300</b>	2	1/0	3/0	4/0					

Length/Ft.	5	10	15	20	25	30	40	50	75
<b>Amps</b>									
<b>75</b>	8	6	6	4	2	1	1/0	2/0	4/0
<b>100</b>	8	6	4	2	1	3/0	3/0	4/0	
<b>125</b>	6	4	2	1	1/0	3/0	4/0		
<b>150</b>	6	4	2	1/0	2/0	3/0	4/0		
<b>175</b>	4	2	1	1/0	2/0	3/0	4/0		
<b>200</b>	4	2	1/0	2/0	3/0	4/0			
<b>225</b>	2	1	1/0	2/0	3/0	4/0			

*NOTE: Charts are a close approximation to calculations, but are not intended for engineering use.*

## PULLEYS

Most small case alternators rated at 100 amps or less come standard with a single groove 2.5" deep vee pulley. The deep vee pulley is designed to provide optimal power transfer for belts measuring 3/8" (10mm) to 1/2" (13mm), as measured across the back of the belt. Keep in mind, 3/8" and 7/16" belts may sit low in the pulley sheave. This will not adversely affect the belt's performance.

Higher output alternators in small, large and extra-large case series are equipped standard with 1/2" dual groove or flat "Serpentine-style" multi-groove pulleys. Should your application require a different pulley than that provided as standard, Balmar may carry an optional pulley more suited to your needs. For a list of optional pulleys, visit <https://balmar.net/products/alternator-accessories/>, or call Balmar Customer Service at +1-360-435-6100.



## ALTERNATOR HEAT

During operation, your alternator will become hot as a result of friction and the generation of inductive current. In some instances, particularly during extended periods of heavy load, alternator case temperatures can exceed 200 degrees (F). If your system is operating with a Balmar multi-stage voltage regulator with optional Alternator Temperature Sensor (MC-TS-A), the regulator will automatically reduce field output if temperatures exceed set safe working limits. While this is an extremely effective protection for the alternator, it should not be depended upon as a part of normal operation. Correction of conditions causing overheating are strongly advised.

**NOTE:** If installing a MC-TS-A Temperature Sensor, do not bend the lug when mounting it to the alternator, or damage may result. Do not hold onto the shrink-wrapped section of the lug when tightening down the bolt. See the appropriate Balmar regulator manual for complete details.

Use extreme caution when handling the alternator or other engine components during or after use. Should your alternator become so hot that it emits a burning smell, or if there is indication of discoloration at the pulley or pulley shaft, shut off the alternator immediately and (once it becomes safe to inspect the alternator) check the tension of the drive belt. Under- and over-tensioned belts are the leading cause of overheating and alternator damage. See the Troubleshooting section, later in the manual, for alternator inspection guidelines.

## FUSING

The American Boat and Yacht Council (ABYC), in its standards for safer boating, recommends that cable runs to your battery banks be fused to protect the boat and owner against damage and injury. Circuit protection, as described by ABYC standards, can be accomplished by installing either a resettable circuit breaker or a fuse. The fuse or breaker you choose will depend on both the amperage rating of the alternator and the size of cable used. The following considerations can be used to determine fusing:

1. The largest available circuit protection device smaller than the amperage capacity of the cable being protected.
2. Larger than the maximum continuous current that will flow in the circuit.

We find that a circuit protection device sized at approximately 140% of your alternator's rated amperage is typically suitable for the circuit being protected. For more info about circuit fusing, see <http://circuitwizard.blueseas.com>.

## ALTERNATOR-TO-BATTERY RATIOS

In order to achieve optimal performance from your charging system, it is essential to determine the capacity your charging system is capable of supporting. In general, the size rating of the alternator should mirror the acceptance rate of the batteries being charged. Differing battery technologies will vary in terms of their acceptance rates. For example, a deep-cycle flooded battery is typically capable of accepting roughly 25 percent of its available capacity at any given time. As a result, we want our alternator's rated output to equal the acceptance rate of the battery being charged when it reaches its full discharge rate.

In other words, a deeply discharged 400 amp hour deep cycle flooded battery would require an alternator rated at 25 percent of 400 amps, or 100 amps to support that bank. In simpler terms, a deep-cycle flooded battery bank will require 25 amps of alternator output for every 100 amp-hours of battery rating. Some newer battery technologies, such as AGMs and spiral wound batteries can accept about 40 percent, and LiFePO<sub>4</sub> Can accept 100% or more of their available capacities. Alternator output should be increased to reflect the optimal ratio between alternator and battery capacity. Failure to meet recommended alternator-to-battery ratios will commonly result in slower charge times, increased alternator heat and wear, and reduced alternator life.

## MULTIPLE BANK CHARGING OPTIONS

When charging a single starting battery, the alternator can be connected to the battery directly, or via an ON/OFF switch. More typically, in a marine system, the alternator will be supporting a smaller starting battery and larger house battery bank -- or a starting battery, along with multiple banks for house loads, inverter loads, windlass or thruster.

Many methods of multi-bank charge control are available, ranging from manual switches to products like Balmar's Digital Duo Charge (which automatically provides charging current to the starting battery whenever charging voltage is present at the house battery). The following section outlines many of the most commonly used options for multiple-bank battery management:

### BATTERY SWITCHES

Available in two primary types -- ON/OFF or A/B/BOTH -- manual switches offer a simple method for charging management. Possible installations include separate cables to each battery bank with ON/OFF switches in line for each bank, or, a common output cable to the common post of the A/B/BOTH switch with an output cable to each battery bank. Field disconnect switches feature terminals where the field output from the regulator to the alternator can be interrupted when the battery switch is turned to the OFF position. This feature ensures that alternator output is discontinued as soon as the battery is disconnected. NEVER operate the alternator with switches in OFF position (doing so could cause alternator diode damage).



- *Advantages: Inexpensive. No substantial voltage drop.*
- *Disadvantages: Requires user interaction. Can be accidentally shut down, causing potential alternator damage. Does not allow for mixed battery technologies.*
- *Voltage Sensing: Battery voltage sensed must always be that of battery being charged. Sense voltage at common side of battery switch or at alternator positive output.*

### BATTERY COMBINERS/SOLENOIDS

Battery combiners enlist high-amperage solenoids to charge multiple battery banks. Below a specific voltage set point, the combiner's solenoids remain open, isolating the individual battery banks. Once the baseline voltage is reached, the solenoid(s) close, combining all of the batteries into one big bank.

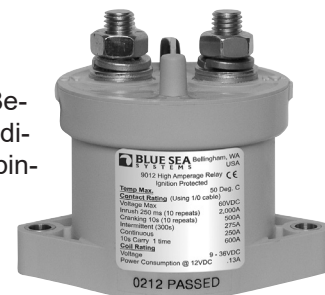

- *Advantages: No user interface required. No substantial voltage drop. Available in 2 or 3-bank models.*
- *Disadvantages: Moderately expensive. Does not allow for mixed battery technologies.*
- *Voltage Sensing: Sense voltage at common side of combiner or at alternator positive output.*

### BATTERY ISOLATOR

Isolating diodes direct charging current to the battery bank with the greatest demand. Best suited for battery banks that are comparable in size and degree of discharge. Isolators are not necessarily the best choice when charging house and start battery banks. Only one battery bank can be sensed by the regulator, so under or over-charging can be a substantial issue if batteries are dissimilar in capacity or degree of charge. Diodes can drop voltage at the battery side of the isolator by nearly a full volt, which means that the alternator is forced to increase voltage far in excess of that needed by the batteries.

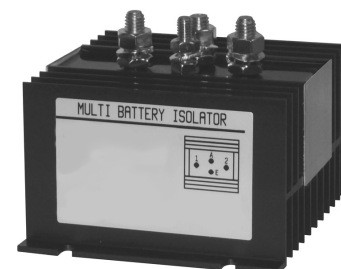

- *Advantages: No user interface required. Reasonably priced. Available in 2 or 3-bank models.*
- *Disadvantages: Substantial voltage drop. Can only sense voltage at one battery bank. May drive voltage at secondary battery bank to dangerously high levels. May hold high voltage for too long at smaller bank. Tendency to under- or over-charge secondary (non-sensed) battery bank. Greater chance of early battery failure.*
- *Voltage Sensing: Voltage must be sensed at most commonly used battery bank (typically house). Connect sense wire to battery side of isolator or positive post of battery being sensed.*

## DIGITAL DUO CHARGE

Balmar's Digital Duo Charge connects between the house and start (secondary) batteries -- keeping the two banks separate until the unit senses 13 volts (26@24V) at the house battery. Once voltage is reached, the Duo Charge supplies up to 30A to the secondary bank. Voltage is regulated at the secondary bank based on a preset program chosen by the user to reflect the secondary battery type. Standard and deep cycle flooded, gel and AGM battery types are supported. Optional battery temperature sensing and solenoid drive terminals are included. 12 or 24-volt settings.



- *Advantages: No user interface required. Selectable programs ensure proper voltage control -- even with varied battery bank capacities and mixed battery constructions. Amperage limits require smaller wire gauge. Works with DC or shore power charge sources. Simplifies charging control for alternator and regulator.*
- *Disadvantages: 30-amp maximum output may not support larger secondary banks (bow thruster, windlass, etc.) without the use of manual solenoid control.*

## TWO ALTERNATORS (SINGLE ENGINE)

Should more charging power be required than is conveniently available from the engine's primary alternator, many boaters choose to install a second alternator. In these applications, alternators can be used separately as dedicated charge sources for the various battery banks, or the outputs from both alternators can be combined to provide a single-source of charging.

Balmar's voltage regulator model MC-612-DUAL is designed specifically for this type of application, providing a separate field terminal pin for each alternator, and the ability to select between temperature sensing at a single alternator and two battery banks, or temperature sensing at two alternators and a single battery bank. This type of system is commonly used to supply a large house bank, with a Duo Charge unit providing charging current to the starting battery. For more information on the MC-612-DUAL, visit the Balmar website at [www.balmar.net](http://www.balmar.net).

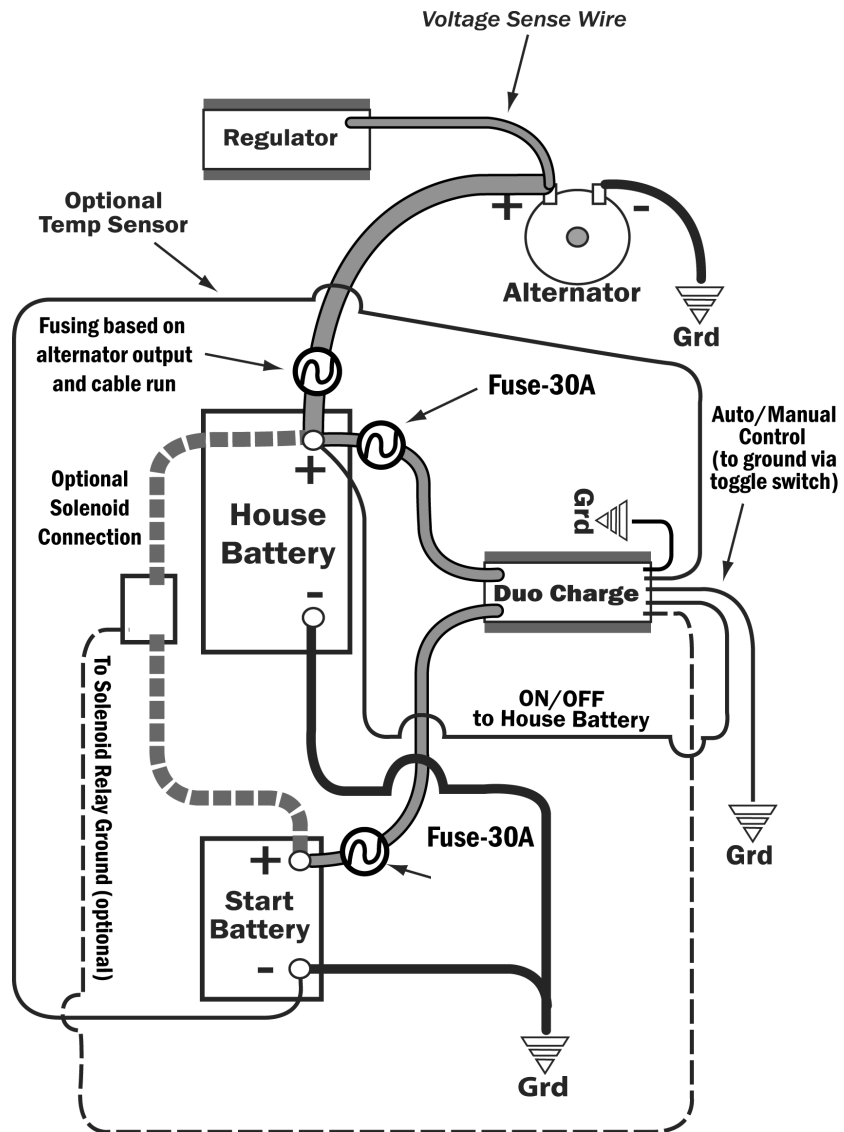

- *Advantages: Provides substantial increase in available charging amperage. Builds in system redundancy.*
- *Disadvantages: Requires addition of new bracketry and upgraded crankshaft pulleys. Potentially expensive*
- *Voltage Sensing: Depends on whether alternators are dedicated to specific banks, or if they are combined to support a single bank. Voltage must be sensed at the battery(ies) being charged.*

# TWIN ENGINE ISSUES

Twin engine applications pose some unique challenges in addressing battery needs. Some primary charging configurations are as follows:

1. Dedicate Alternator #1 to charge engine starting batteries. Dedicate Alternator #2 to the house battery bank.
2. Combine outputs from Alternator #1 and Alternator #2 to provide increased charging amperage for the main (house) battery bank, and supply the engine (and other secondary) batteries via Digital Duo Charges or combin-ers. Combining the output from two alternators on two engines will require the use of Balmar's Centerfielder II (described below).

This configuration will require that both alternators are equipped with Max Charge regulators, which are designed to provide sufficient field current to drive two alternators. For additional information, download the Centerfielder II instructional manual from the Balmar website; [www.balmar.net](http://www.balmar.net).

**CENTERFIELDER II** Balmar's Centerfielder II enables twin engine systems to balance alternator output, so available amperage from both alternators can be combined to support larger battery banks. The Centerfielder II monitors field and ignition wires on port and starboard voltage regulators (*Max Charge 12-volt or 24 volt regulators are uniquely engineered for dual alternator operation, and are the only regulators recommended for use with the Centerfielder II*).

When both regulators are up and running, the Centerfielder II identifies the dominant regulator and splits its field to supply both alternators with the same excitation current. This allows the user to supply output from both alternators to the same battery bank. In multi-bank battery systems, the output can be directed to additional banks via Digital Duo Charge or other control device described on Pages 5 to 6. A typical system wiring design is shown below:

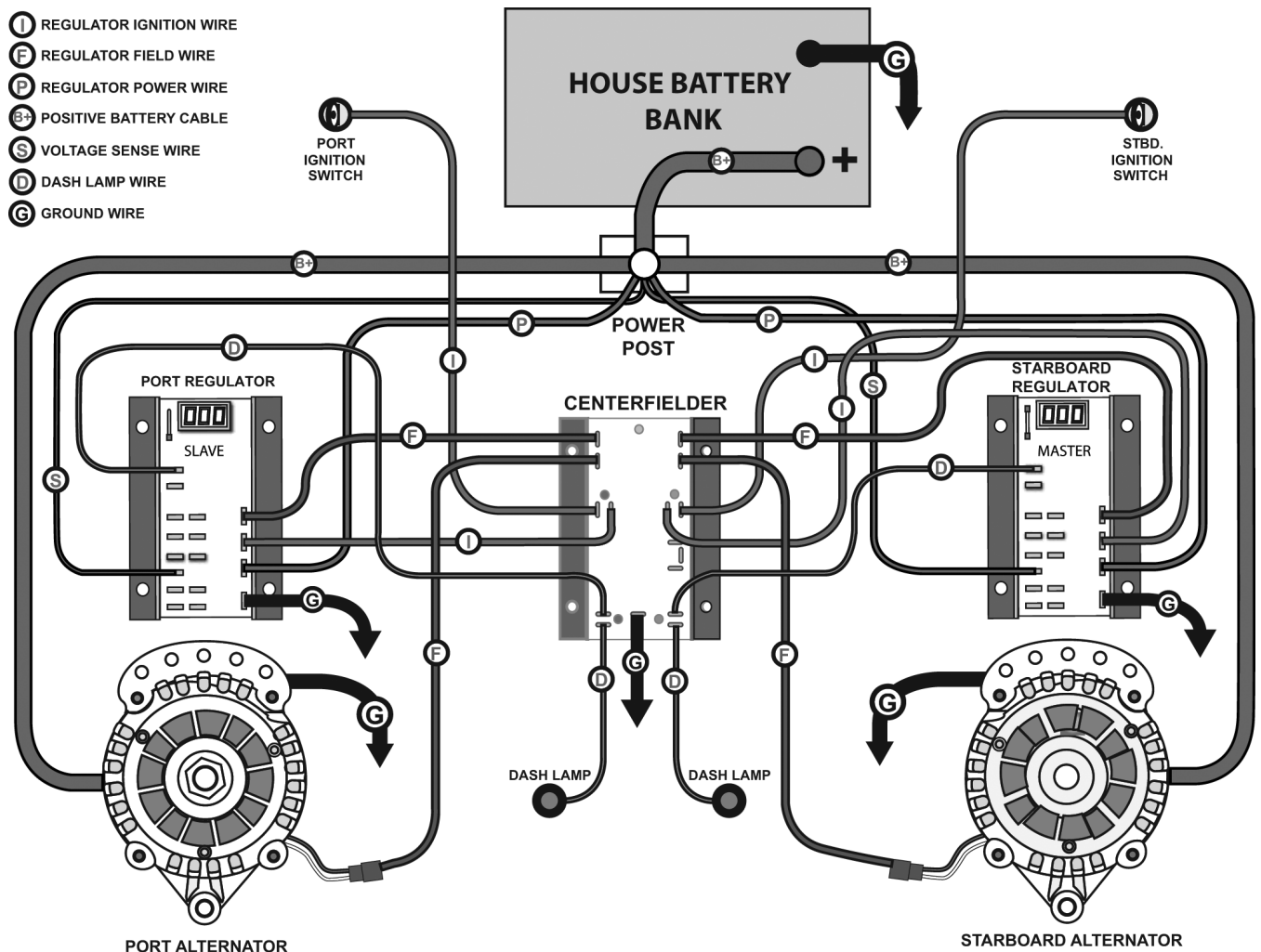

# INSTALLATIONS BY ALTERNATOR SERIES

## 6-SERIES ALTERNATORS

Six Series models are among the most frequently installed Balmar alternators. Designed to replace a wide range of OEM alternators on most common marine gasoline or diesel engines, Alternators in the 6-Series family feature isolated ground terminals (see grounding information on Page 3), Smart Ready® internal regulation, and a low-voltage, low current D+ output that can be used to supply a dash lamp signal. 6-Series alternators feature three mounting styles:

- 60-Series models, which feature a saddle mount with a 3.15" space between front and rear mounting feet.
- 621-Series models, which feature a single-foot (spindle) mount. These alternators include a 1" mounting foot for Motorola-style engine applications, and a bushed 1" spacer, which allows the 621-Series to be installed on engines requiring a 2" (Delco-style) single foot mount.
- 604-Series models, which feature a J-180, saddle mount with a 4" space between the front and rear mounting feet.

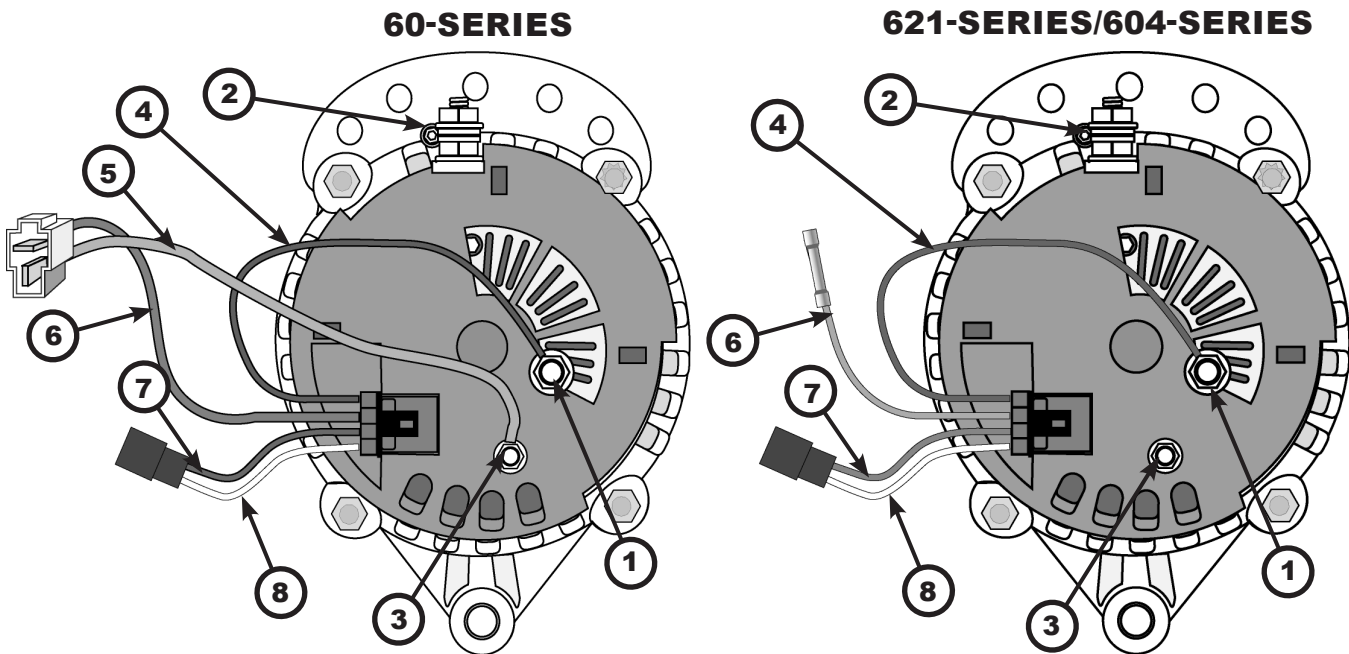

- 1. (B+) Positive Output Terminal** - Must be connected via properly-sized cable to the battery or batteries being charged. Cable size is determined by alternator output and length of cable run. See Page 3 for wiring size chart.
- 2. Negative Terminal (Ground)** - Must be connected to system ground via properly sized cable. Cable size is determined by alternator output and length of cable run. See Page 3 for wiring size chart. Ensure that the ground cable is adequately supported to supply strain relief.
- 3. (D+) Output** - Provides a ground signal used in some systems to drive an Indicator or dash lamp.
- 4. Internal Regulator Voltage Sense Wire (RED)** - Provides sensing voltage when the internal regulator is used. This can be left on the B+ stud when not being used.
- 5. Dash Lamp Wire (BLUE - 60-Series only)** - Included in the Yanmar-type T-plug. Typically not used.
- 6. Internal Regulator Excite Wire (BROWN)** - Provides switched source of voltage to the alternator's internal regulator. Only connected when the internal regulator is being used. See diagram on Page 9.
- 7. External Field Wire (BLUE)** - Connects to external voltage regulator via wiring harness.
- 8. Stator Output Wire (WHITE)** - Provides an unrectified source of AC voltage which can be used as a signal for an electric tachometer. The 6-Series alternator is a 12-pole alternator, meaning that the AC/Stator output will provide 12 pulses per alternator revolution. In 24-volt systems, the Stator Wire will connect to the ORANGE wire in the regulator wiring harness.
- 9. Alternator Temp Sensor (Not shown)** - The (Optional) MC-TS-A is typically mounted on the small stud on the rear, side of the case, at approx the 10 o'clock position in the above drawings.

*An unsupported cable may damage the positive or negative terminals, resulting in damage to alternator, regulator and wiring. Ensure that cables are adequately supported to supply strain relief.*



## USING THE SMART-READY® INTERNAL VOLT-AGE REGULATOR

The 6-Series and XT-Series alternators are unique among Balmar alternators, in the fact that it is equipped with a single stage Smart Ready® internal regulator. Designed to be used as a stand-alone or emergency spare, the Smart Ready® regulator can be wired, as shown at right, to take over in the case of an external regulator failure.

By installing a double throw toggle switch from a switched source of voltage the user can quickly switch from one regulator to the other by shutting down the engine, flipping the switch and restarting the engine.

NOTE: The alternators can only be controlled by one voltage regulator at a time.

DO NOT connect the internal regulator's (BROWN) excite wire and the external regulator's (BROWN) excite wire to ignition voltage at the same time. Doing so could result in an over voltage condition that could harm the alternator, regulators and batteries being charged.

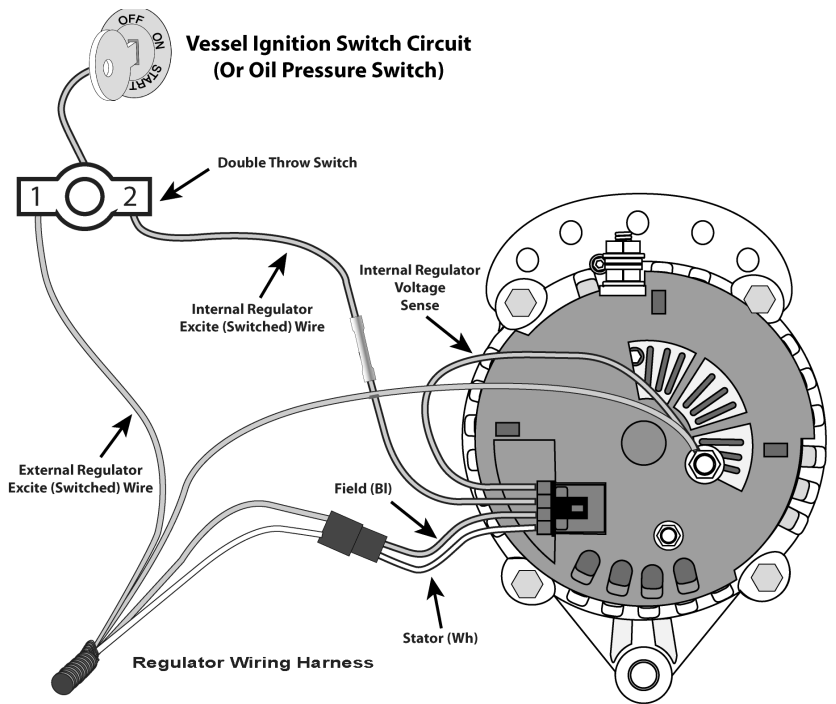

### WARNING

**The engine MUST be turned off prior to switching between external and internal regulators. Failure to do so will result in damage to the internal regulator.**

## USING THE SMART READY® REGULATOR WITH A BATTERY ISOLATOR

The Smart Ready® internal regulator requires power at the alternator's positive output to properly regulate charging voltage. In systems where charging output is directed to multiple battery banks by a diode-based battery isolator, the alternator's positive output is isolated from battery voltage by the diodes.

The following diagram illustrates the use of a 3-amp, 200-volt axial diode to bleed a small amount of current to the positive output post when the internal regulator is activated. Note that the internal regulator's (RED) sense wire must be connected to the isolator output post that supplies the primary (house) battery bank. The axial diode is spliced into the (BROWN) ignition wire and is connected to the alternator's positive output post. Ensure that the axial diode output (indicated by bar on the diode, is connected closest to the alternator's positive output post.

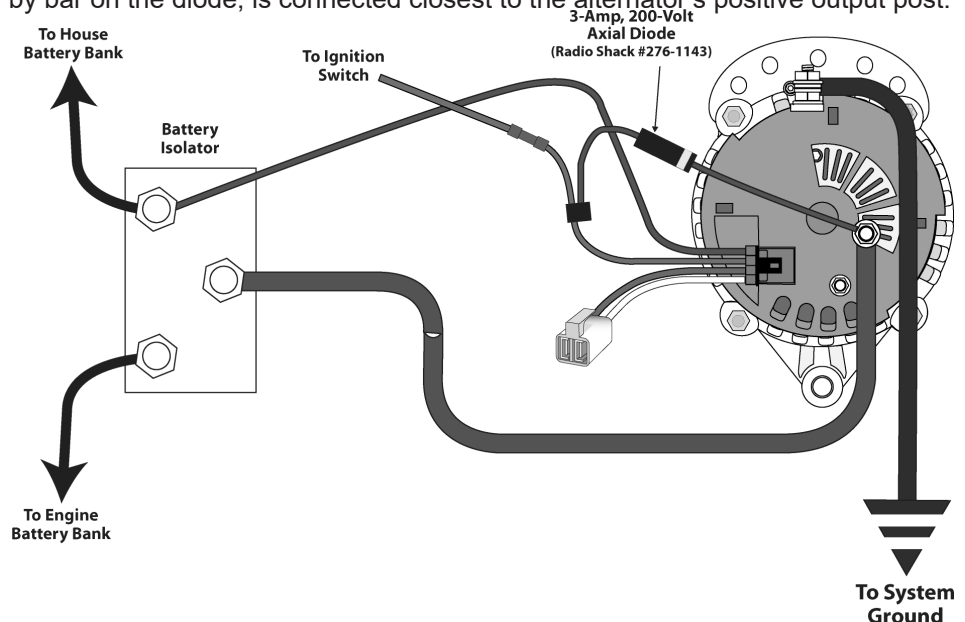

## XT-SERIES ALTERNATORS – 170A/12V, 90A/24V

XT alternators are Smart Ready® and feature 16 stator poles

XT-Series alternators are available in three mounting configurations:

- **SF models:** 1" or 2" single foot mount Smart Ready®
- **DF models:** 3.15" ID saddle mount Smart Ready®
- **VT models:** Vortec mount Smart Ready® (found on many GM Gasoline engines)

XT-Series SF, DF and VT alternators are available in both Case Ground and Isolated Ground versions. The following diagrams show each of these versions.

### Dual foot (3.15") mount Case Ground:

1. **Positive Output Terminal** - Must be connected via properly-sized cable to the battery or batteries being charged. Cable size is determined by alternator output and length of cable run. See Page 3 for wiring size chart.
2. **Stator Output Wire (WHITE)** - Provides an unrectified source of AC voltage which can be used as a signal for an electric tachometer.
3. **External Field Wire (BLUE)** - Connects to external voltage regulator via wiring harness.
4. **Internal Regulator Excite Wire (BROWN)** - Provides switched source of voltage to the alternator's internal regulator. Only connected when the internal regulator is being used.
5. **Internal Regulator Voltage Sense Wire (RED)** - Provides sensing voltage when the internal regulator is used
6. **Dash Lamp Wire (BLUE)** - Included in the Yanmar-type T-plug. Typically not used.
7. **Temp Sensor** - Install the ring terminal end of the (Optional) MC-TS-A here. Do not bend the heat shrink or ring terminal.

*CAUTION: Positive Output cable must be properly supported to ensure that terminal posts are protected from excessive weight and torque. Failure to provide adequate strain relief could result in damage to the alternator and cables.*

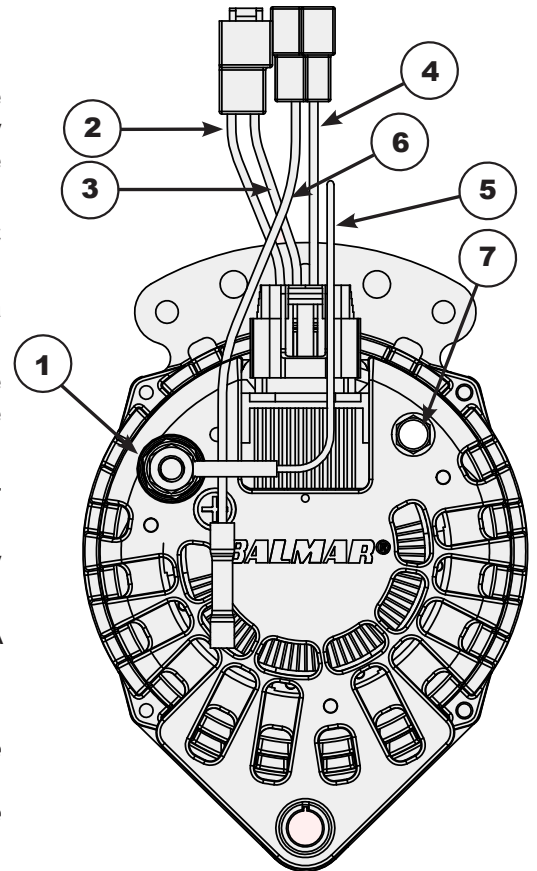

NOTES

### Single-foot and Vortec mount versions Case Ground:

1. **Positive Output Terminal** - Must be connected via properly-sized cable to the battery or batteries being charged. Cable size is determined by alternator output and length of cable run. See Page 3 for wiring size chart.
2. **Stator Output Wire (WHITE)** - Provides an unrectified source of AC voltage which can be used as a signal for an electric tachometer.
3. **External Field Wire (BLUE)** - Connects to external voltage regulator via wiring harness.
4. **Internal Regulator Excite Wire (BROWN)** - Provides switched source of voltage to the alternator's internal regulator. Only connected when the internal regulator is being used.
5. **Internal Regulator Voltage Sense Wire (RED)** - Provides sensing voltage when the internal regulator is used.
6. **Temp Sensor** - Install the ring terminal end of the (Optional) MC-TS-A here. Do not bend the heat shrink or ring terminal.

*CAUTION: Positive Output cable must be properly supported to ensure that terminal posts are protected from excessive weight and torque. Failure to provide adequate strain relief could result in damage to the*

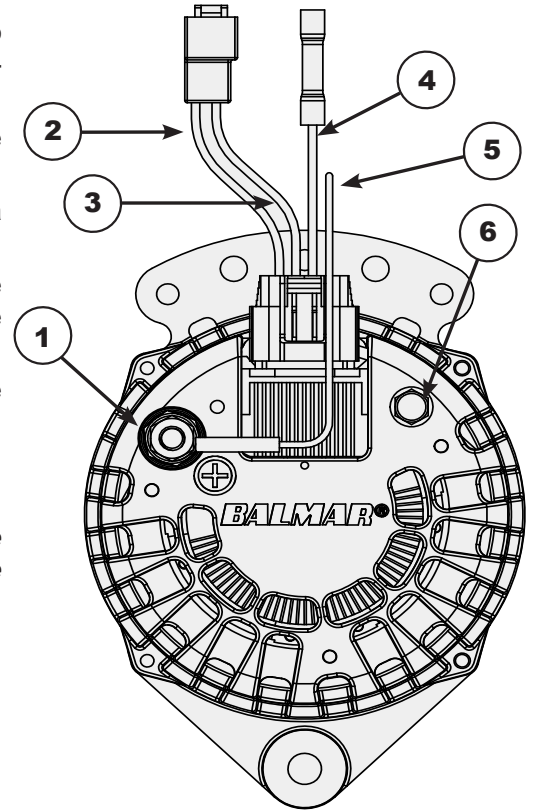

XT-SF-170-XX shown. Wiring is the same for Vortec model XT-VT-170-XX

### Dual foot (3.15") mount Isolated Ground:

1. **Positive Output Terminal** - Must be connected via properly-sized cable to the battery or batteries being charged. Cable size is determined by alternator output and length of cable run. See Page 3 for wiring size chart.
2. **Stator Output Wire (WHITE)** - Provides an unrectified source of AC voltage which can be used as a signal for an electric tachometer.
3. **External Field Wire (BLUE)** - Connects to external voltage regulator via wiring harness.
4. **Internal Regulator Excite Wire (BROWN)** - Provides switched source of voltage to the alternator's internal regulator. Only connected when the internal regulator is being used.
5. **Internal Regulator Voltage Sense Wire (RED)** - Provides sensing voltage when the internal regulator is used.
6. **Dash Lamp Wire (BLUE)** - Included in the Yanmar-type T-plug. Typically not used.
7. **Negative Terminal (Ground)** - Must be connected to system ground via properly sized cable. Cable size is determined by alternator output and length of cable run. See Page 3 for wiring size chart. Ensure that the ground cable is adequately supported to supply strain relief. *The wire exiting the alternator and attached to this terminal MUST remain in place for the alternator to function.*
8. **Temp Sensor** - Install the ring terminal end of the (Optional) MC-TS-A here. Do not bend the heat shrink or ring terminal.

*CAUTION: Positive Output and Negative (Ground) cable must be properly supported to ensure that terminal posts are protected from excessive weight and torque. Failure to provide adequate strain relief could result in*

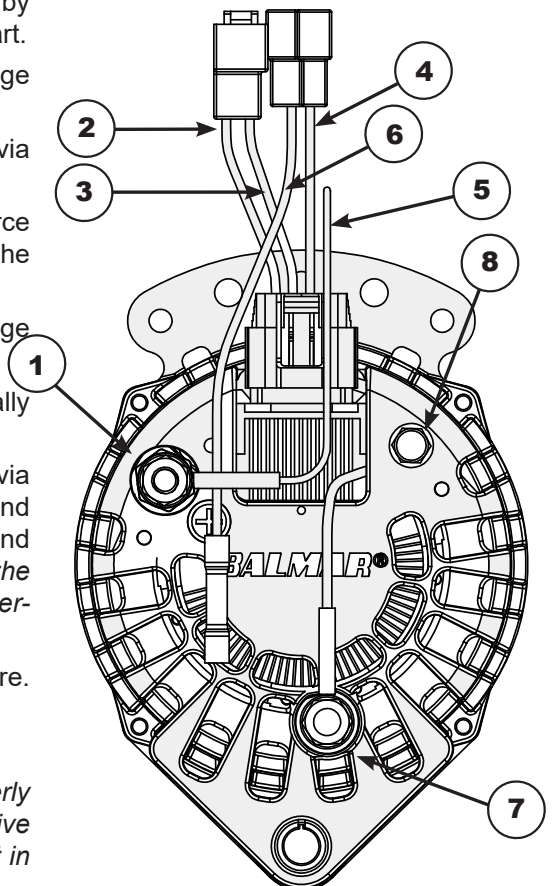

## Single-foot and Vortec mount versions Isolated Ground:

- 1. Positive Output Terminal** - Must be connected via properly-sized cable to the battery or batteries being charged. Cable size is determined by alternator output and length of cable run. See Page 3 for wiring size chart.
- 2. Stator Output Wire (WHITE)** - Provides an unrectified source of AC voltage which can be used as a signal for an electric tachometer.
- 3. External Field Wire (BLUE)** - Connects to external voltage regulator via wiring harness.
- 4. Internal Regulator Excite Wire (BROWN)** - Provides switched source of voltage to the alternator's internal regulator. Only connected when the internal regulator is being used.
- 5. Internal Regulator Voltage Sense Wire (RED)** - Provides sensing voltage when the internal regulator is used.
- 6. Negative Terminal (Ground)** - Must be connected to system ground via properly sized cable. Cable size is determined by alternator output and length of cable run. See Page 3 for wiring size chart. Ensure that the ground cable is adequately supported to supply strain relief. *The wire exiting the alternator and attached to this terminal MUST remain in place for the alternator to function.*
- 7. Temp Sensor** - Install the ring terminal end of the (Optional) MC-TS-A here. Do not bend the heat shrink or ring terminal.

*CAUTION: Positive Output and Negative (Ground) cable must be properly supported to ensure that terminal posts are protected from excessive weight and torque. Failure to provide adequate strain relief could result in damage to the alternator and cables.*

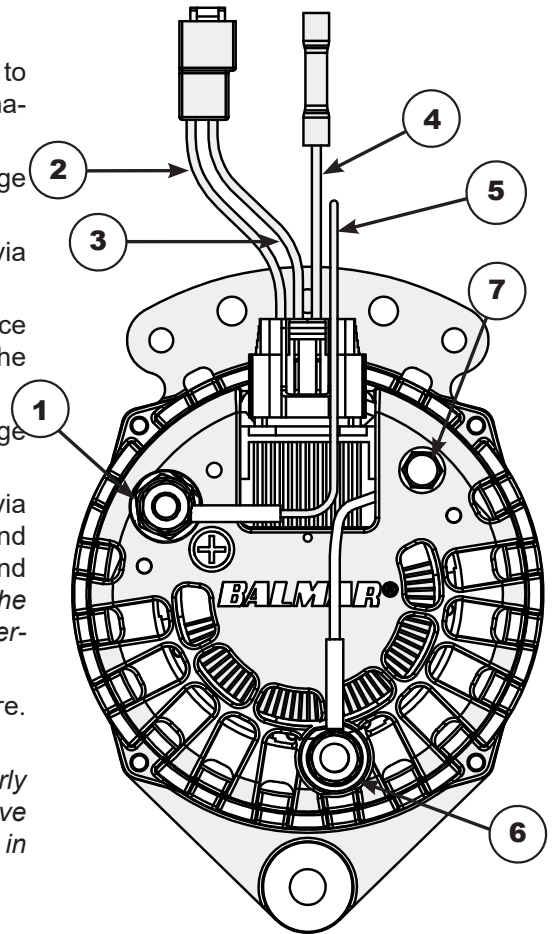

XT-SF-170-IG-XX shown. Wiring is the same for Vortec model XT-VT-170-IG-XX

NOTES

## XT-SERIES ALTERNATORS – 250A

XT alternators are Smart Ready®, feature 16 stator poles and are Case-Ground

XT-Series alternators are available in four mounting configurations:

- **SF models: 1" or 2" single foot mount Smart Ready®**
- **DF models: 3.15" ID saddle mount Smart Ready® (Found on many Yanmar engines)**
- **VT models: Vortec mount Smart Ready® (found on many GM Gasoline engines)**
- **XT-DF4 Series: 4" Dual Foot mount Smart Ready® (Saddle, J-180)**

- 1. Positive Output Terminal** - Must be connected via properly-sized cable to the battery or batteries being charged. Cable size is determined by alternator output and length of cable run. See Page 3 for wiring size chart.
- 2. Stator Output Wire (WHITE)** - Provides an unrectified source of AC voltage which can be used as a signal for an electric tachometer.
- 3. External Field Wire (BLUE)** - Connects to external voltage regulator via wiring harness.
- 4. Internal Regulator Voltage Sense Wire (RED)** - Provides sensing voltage when the internal regulator is used.
- 5. Internal Regulator Excite Wire (BROWN)** - Provides switched source of voltage to the alternator's internal regulator. Only connected when the internal regulator is being used.
- 6. Temp Sensor (Optional)** - MC-TS-A sensor. Do not bend the heat shrink or ring terminal

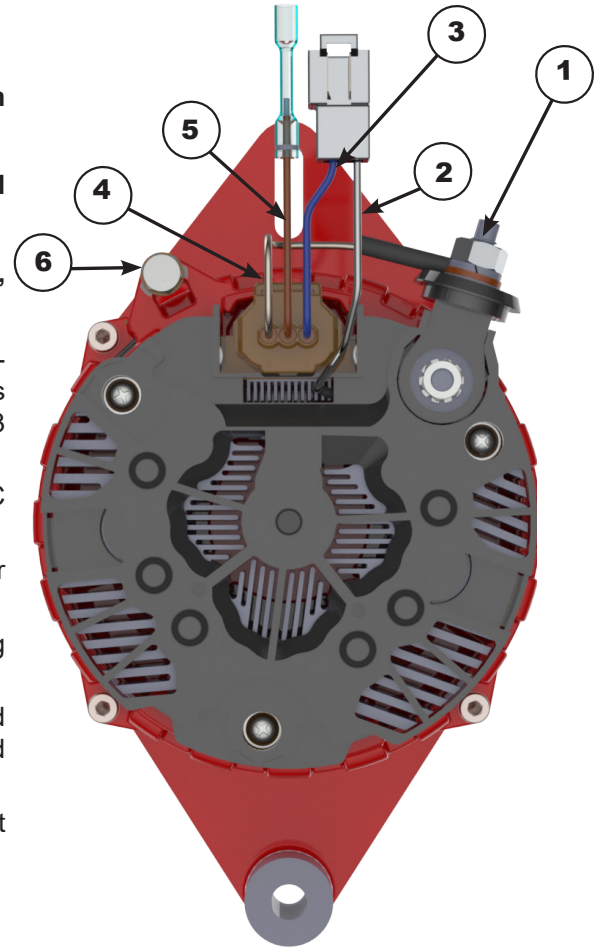

## 94-SERIES & 94LY-SERIES ALTERNATORS

Large case 94-Series alternators are designed to provide 165 or 210 amps at 12 volts, or 140 amps at 24 volts. Mounting is a 2" single-foot Delco-style mount for 94-series, and Dual Foot w/3.15 for the 94LY-series. Alternators in the 94-Series feature isolated ground terminals, external regulation and 12-pole stator output.

- 1. Positive Output Terminal** - Must be connected via properly-sized cable to the battery or batteries being charged. Cable size is determined by alternator output and length of cable run. See Page 3 for wiring size chart.
- 2. Negative Terminal (Ground)** - Must be connected to system ground via properly sized cable. Cable size is determined by alternator output and length of cable run. See Page 3 for wiring size chart.
- 3. Stator Output** - Unrectified source of AC voltage which can be used as a signal for an electric tachometer. In 12-volt systems, stator terminal will connect to WHITE wire. In 24-volt systems, the Stator Wire will connect to the ORANGE wire in the regulator wiring harness.
- 4. External Field Wire (BLUE)** - Connects to external voltage regulator via wiring harness.
- 5. Temp Sensor (Not Shown)** - There is a tapped hole on the side of the rear casing for the (Optional) MC-TS-A sensor. Do not bend the heat shrink or ring terminal

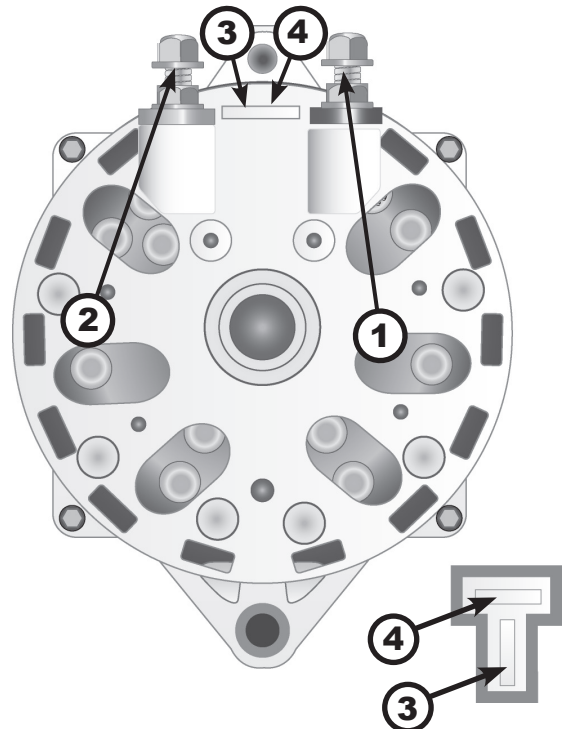

*An unsupported cable may damage the positive or negative terminals, resulting in damage to alternator, regulator and wiring. Ensure that cables are adequately supported to supply strain relief.*

## 95-SERIES ALTERNATORS

Large case 95-Series alternators are designed to provide outputs of 165 or 210 amps at 12 volts, or 140 amps at 24 volts. Mounting is a 4" ID J-180 saddle-style mount. Alternators in the 95-Series feature isolated ground terminals, external regulation and 12-pole stator output.

- 1. Positive Output Terminal** - Must be connected, via properly-sized cable to the battery or batteries being charged. Cable size is determined by alternator output and length of cable run. See Page 3 for wiring size chart.
- 2. Negative Terminal (Ground)** - Must be connected to system ground via properly sized cable. Cable size is determined by alternator output and length of cable run. See Page 3 for wiring size chart.
- 3. Stator Output** - Unrectified source of AC voltage which can be used as a signal for an electric tachometer. In 12-volt systems, stator terminal will connect to WHITE wire. In 24-volt systems, the Stator Wire will connect to the ORANGE wire in the regulator wiring harness.
- 4. External Field Terminal** - Connects to external voltage regulator via wiring harness.
- 5. Temp Sensor (Not Shown)** - There is a tapped hole on the side of the rear casing for the (Optional) MC-TS-A sensor. Do not bend the heat shrink or ring terminal

*An unsupported cable may damage the positive or negative terminals, resulting in damage to alternator, regulator and wiring. Ensure that cables are adequately supported to supply strain relief.*

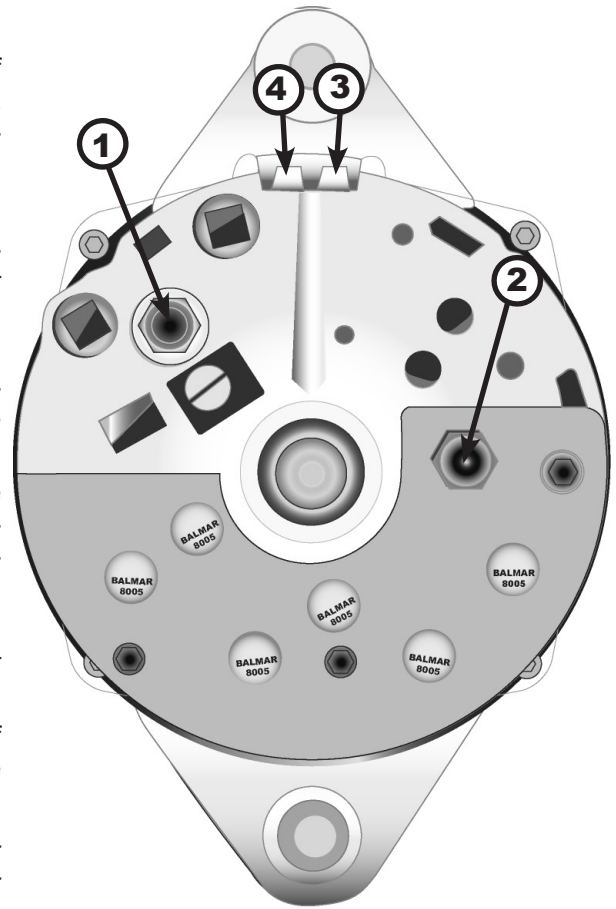

*An unsupported cable may damage the positive or negative terminals, resulting in damage to alternator, regulator and wiring. Ensure that cables are adequately supported to supply strain relief.*

## 97 EHD-SERIES ALTERNATORS

97 EHD-Series alternators are designed to provide outputs of 185 or 265 amps at 12 volts, or 190 amps at 24 volts. Mounting is a 4"ID J-180 saddle mount. Alternators feature case ground or Isolated ground, external regulation and 12-pole stator output.

**NOTE:** The connections on the different versions of this alternator are NOT THE SAME. Refer to the tags on your alternator, and the correct drawing here for guidance.

- 1. Positive Output Terminal** - Must be connected via properly-sized cable to the battery or batteries being charged. Cable size is determined by alternator output and length of cable run. See Page 3 for wiring size chart.
- 2. Negative Terminal (Ground)** - Must be connected to system ground via properly sized cable. Cable size is determined by alternator output and length of cable run. See Page 3 for wiring size chart.
- 3. Stator Output** - Unrectified source of AC voltage which can be used as a signal for an electric tachometer. In 12-volt systems, stator terminal will connect to WHITE wire. In 24-volt systems, the Stator Wire will connect to the ORANGE wire in the regulator wiring harness. Any terminal can be used.
- 4. External Field Terminal** - Connects to external voltage regulator via wiring harness. **NOTE:** There are two terminals in the location shown. One connects to the BLUE field wire from the regulator, the other must be connected to the ground terminal.
- 5. Temp Sensor (Not Shown)** - There is a tapped hole on the side of the rear casing for the (Optional) MC-TS-A sensor. Do not bend the heat shrink or ring terminal.

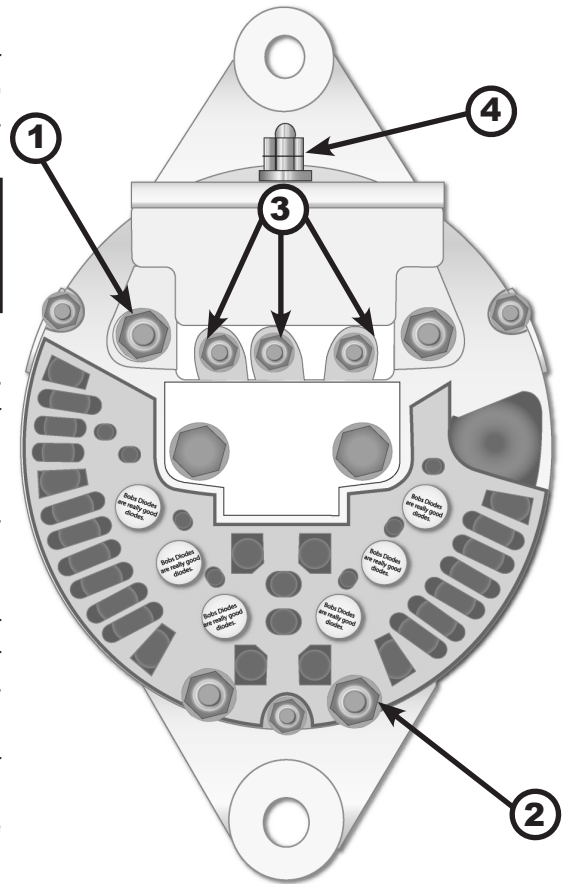

**ISOLATED GROUND 24V**

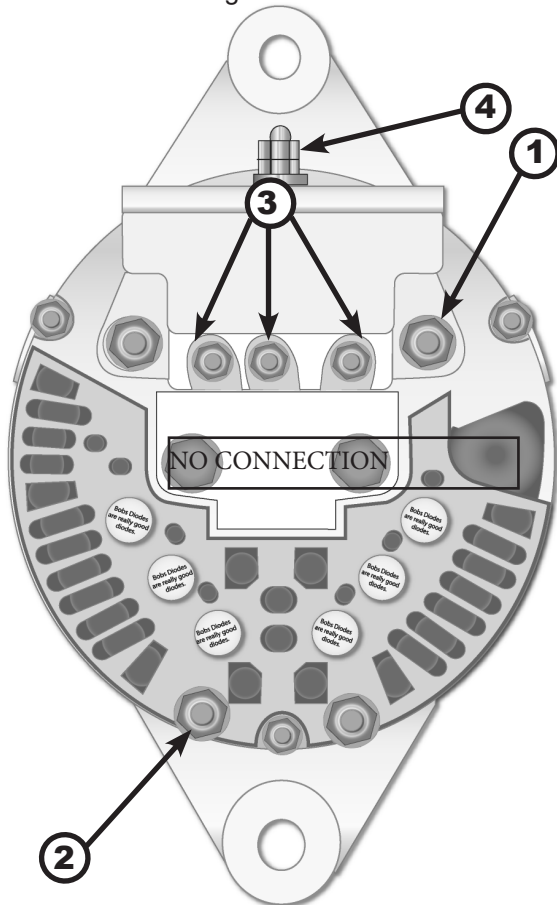

**ISOLATED GROUND 12V**

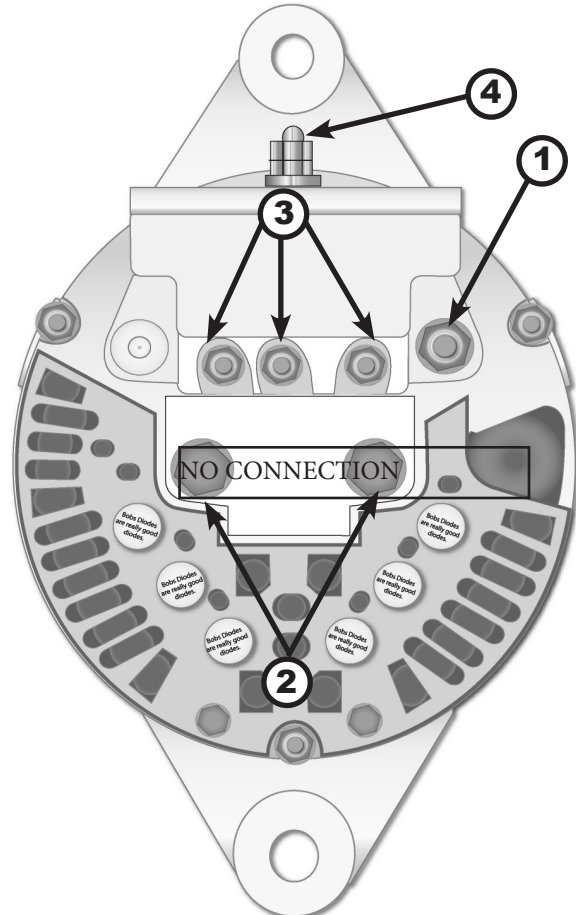

**CASE GROUND VERSION**

## 97 XD-SERIES ALTERNATORS

97XD-Series alternators are designed to provide 240 amps at 12 volts, or 120-190 amps at 24 volts. Mounting is a 4"ID J-180 saddle mount. They require external regulation and 12-pole stator output. Both case-ground and isolated Ground versions are available.

An adapter is included to connect the 5-pin connector on the back of the alternator with the 2-pin connector on the harness.

- 1. Positive Output Terminals(B1+ B2+)** - Must be connected via properly-sized cable(s) to the battery or batteries being charged. Cable size is determined by alternator output and length of cable run. See Page 3 for wiring size chart.
- 2. Stator Output** (White wire in adapter) - Unrectified source of AC voltage which can be used as a signal for an electric tachometer. In 12-volt systems, stator terminal will connect to WHITE wire. In 24-volt systems, the Stator Wire will connect to the ORANGE wire in the regulator wiring harness. Any terminal can be used.
- 3. External Field Terminal** (Blue wire in adapter) - Connects to external voltage regulator via wiring harness. NOTE: There are two terminals in the location shown. One connects to the BLUE field wire from the regulator, the other must be connected to the ground terminal.
- 4. Temp Sensor** - Tapped hole for the (Optional) MC-TS-A sensor. Do not bend the heat shrink or ring terminal. This terminal can also be used to connect a Negative (-) battery cable.
- 5. Negative Output Terminal (B-)** - ONLY ON ISLOATED GROUND VERSIONS (NOT SHOWN) - Must be connected via properly-sized cable(s) to the battery or batteries being charged. Cable size is determined by alternator output and length of cable run. See Page 3 for wiring size chart.

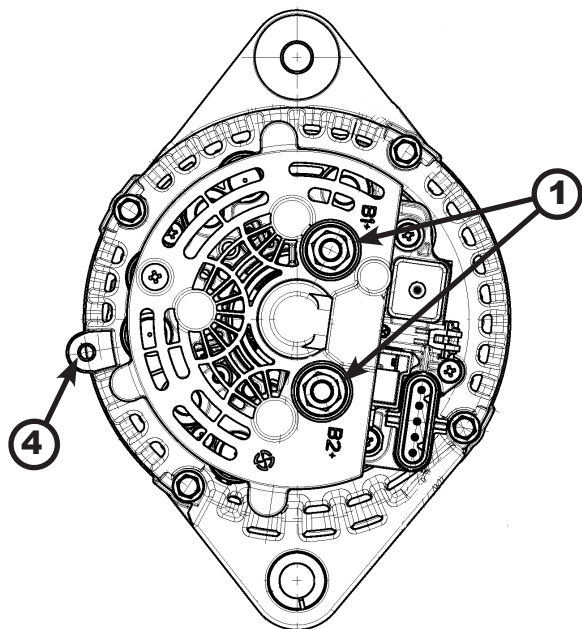

NOTE: Do not connect a Negative (-) cable to either of the B+ posts. This WILL short out the alternator and is not covered under warranty. Only Isolated Gound (IG) versions have a B- (Negative) post.



## 98-SERIES ALTERNATORS

Balmar's 98-Series alternators are designed to provide outputs of 310 amps at 12 volts, or 220 amps at 24 volts. Mounting is a 4" ID J-180 saddle mount. Alternators in the 98-Series feature isolated ground terminals and a brushless rotor/stator design that reduces alternator noise, and eliminates key wear points.

- 1. Positive Output Terminal** - Must be connected, via properly-sized cable to the battery or batteries being charged. Cable size is determined by alternator output and length of cable run. See Page 3 for wiring size chart. Either terminal shown may be used.
- 2. Negative Output Post (Ground)** - Must be connected to system ground via properly sized cable. Cable size is determined by alternator output and length of cable run. See Page 3 for wiring size chart.
- 3. Stator Output** - Unrectified AC voltage can be used as a signal for an electric tachometer. In 12-volt systems, stator terminal will connect to WHITE wire. In 24-volt systems, the Stator Wire will connect to the ORANGE wire in the regulator wiring harness. Any terminal can be used. 98-Series are a 14 pole stator output design.
- 4. External Field Terminal** - Connects to external voltage regulator via wiring harness.
- 5. Diode Trio (D+) Output** - Provides a signal that may be required in some systems to drive a charge indicator lamp.
- 6. Temp Sensor (Not Shown)** - There is a tapped hole on the side of the rear casing for the (Optional) MC-TS-A sensor. Do not bend the heat shrink or ring terminal.

*An unsupported cable may damage the positive or negative terminals, resulting in damage to alternator, regulator and wiring. Ensure that cables are adequately supported to supply strain relief.*

### NOTES:

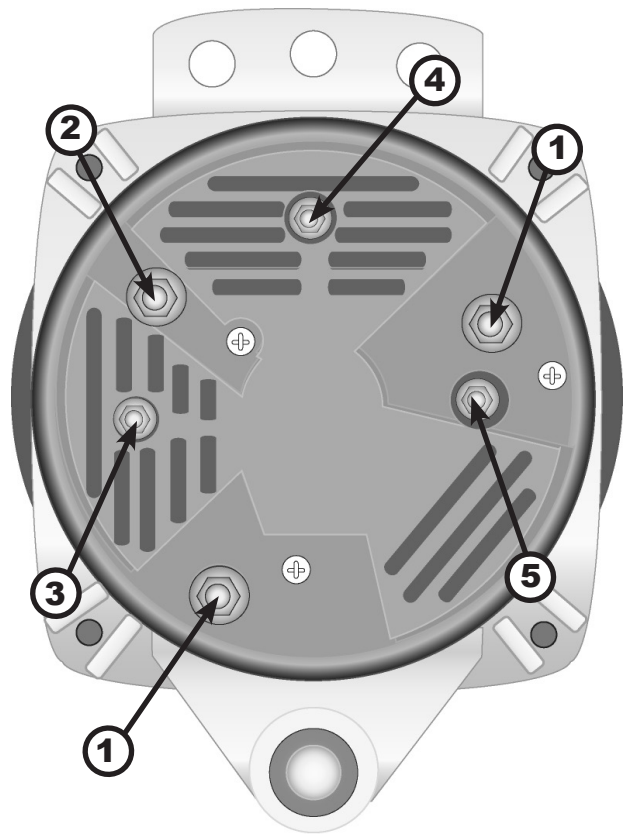

## Air Inlet Kit Installation

**OPTIONAL ACCESSORY - PART #12-98-AIR**

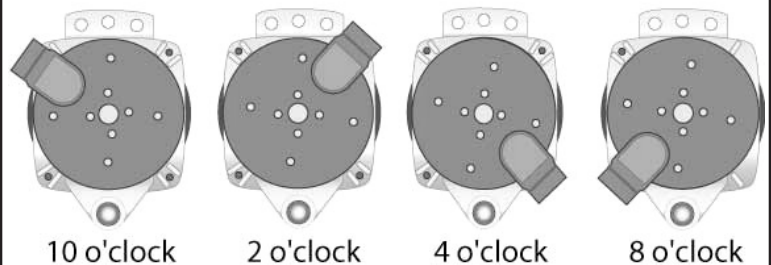

The air inlet back for your Model 98-Series alternator must be aligned in one of the four configurations shown above in order to ensure proper alignment with mounting standoffs included with the inlet assembly. Once the proper mounting angle is determined, holes must be cut at the side of the Air Inlet back to allow cables to be connected to their respective terminal posts. For maximum cooling efficiency, high temperature sealant should be used in gaps surrounding the cables where they enter the air inlet back.



[www.balmar.net](http://www.balmar.net)

# System Troubleshooting

## Regulator Troubleshooting

The majority of charging difficulties can be attributed to damage, corrosion or wear at wiring, fusing or wiring connections. Before attempting to troubleshoot alternator or regulator issues, be sure to address the following:

1. Remove and clean all charging system electrical connections (positive and negative). Check the voltage regulator's harness for continuity. Wires and terminals can and will become corroded, and need to be cleaned or replaced. Ensure that the regulator's ground wires are provided with a clean connection to system ground.
2. Inspect and replace ATC type fuses in the regulator wiring harness if fuse appear to be damaged or corroded. Ensure that the fuse holder is also free of corrosion.
3. Charge all batteries to their proper fully charged state, and determine if they are serviceable. If your batteries are flooded-type, use your hydrometer to determine their condition.
4. Check and tighten alternator belt. If the belt show signs of wear or damage, replace it. Always replace existing belts with the finest quality replacements available.

If batteries and wiring are in suitable condition, use the following tests to determine if charging problems are a result of a faulty alternator or regulator. These tests provide an opportunity to isolate the alternator, regulator and wiring harness in order to determine the problem source. In order to perform these tests, you will need an independent DC meter (preferably a digital type). In an emergency, a DC light bulb or test light can be used to help determine if power or working grounds exist. An amp meter and a battery hydrometer with a thermometer are also helpful diagnostic tools.

### Voltage Regulator Testing

Set your voltmeter to VDC and connect the negative lead to the BLACK ground wire at the regulator as shown at the diagram at right.

1. With the ignition turned OFF, check voltage on the RED (power), Voltage Sense (Terminal #9), BLUE (field) and BROWN (Ignition) wires in the regulator plug.

Voltages should be as follow:

- RED wire equal to battery voltage
- Terminal #9 RED wire equal to battery voltage
- BLUE wire zero volts
- BROWN wire zero volts

2. With the ignition in the ON position (engine not running), check voltage on the RED (power), Secondary RED on Terminal #9 (voltage sense) BLUE (field) and BROWN (ignition) wires in the regulator plug:

- RED wire equal to battery voltage
- Terminal #9 RED wire equal to battery voltage
- BLUE wire The voltage on this wire can vary. It is typically between 4V and 11V on 12v systems and 8v to 22v on 24v systems.
- BROWN wire equal to battery voltage

PLEASE NOTE: In systems where the ignition (BROWN) wire is supplied power via an oil pressure switch, jump directly from test #1 to test #3.

3. With the ignition in the ON position (with engine running at 1,400 rpm fast idle), check voltage on the RED (power), Secondary RED on Terminal #9 (voltage sense) BLUE (field) and BROWN (ignition) wires in the regulator plug. Voltages should be as follows:

- RED wire equal to battery voltage
- Terminal #9 RED wire equal to battery voltage
- BLUE wire The voltage on this wire can vary. It is typically between 4V and 11V on 12v systems and 8v to 22v on 24v systems.
- BROWN wire equal to battery voltage

If voltage is not present on the RED, the BROWN and the Positive Battery Sense Wire, the regulator will not work.

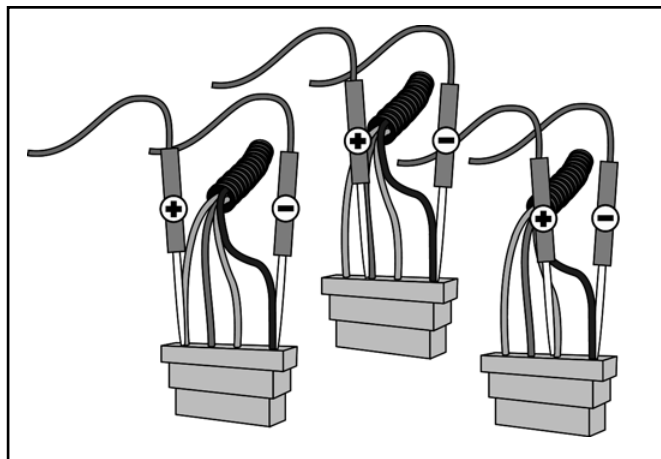

If voltage is as expected at the RED the BROWN and Positive Battery Sense wire, and there is zero, or an unexpected voltage reading at the BLUE wire, contact our technical support staff at +1(360) 435-6100, or e-mail us at [balmar@balmar.net](mailto:balmar@balmar.net).

If all voltages at the regulator meet expectations, yet the alternator is not producing charging current, test the alternator. The following tests are recommended for determining alternator functionality.

## Alternator Testing

TEST #1 - The following test is used to isolate the alternator and determine if the failure is a result of the alternator. Once again, testing at either the alternator or regulator is only effective if the wiring, fusing and batteries have been determined to be in correct working order. The alternator and regulator can be tested for function by determining if a magnetic field exists at the alternator's pulley shaft or rear bearing. To test:

1. With the ignition in the OFF position, place the tip of a non-magnetic steel screwdriver near the nut on the pulley shaft or near the rear bearing of the alternator. There should be no evidence of a magnetic field pulling the screwdriver toward the alternator. (A slight amount of magnetism may be present, due to residual voltage in the alternator).
2. Engage the ignition, without starting the engine, to activate the voltage regulator. If an oil pressure switch is used, a jumper between the RED and BROWN wires in the Ford-style plug will activate the regulator.
3. After allowing time for the regulator's start-up delay, place the head of a steel screwdriver near the nut on the pulley shaft or near the rear bearing of the alternator. There should be substantial magnetic pull. If a magnetic field is present, the voltage regulator, alternator brushes and rotor are likely to be working properly.

If there is little or no magnetic pull at the pulley shaft or at the rear bearing, initiate the following test:

With the key off and the engine off, remove the large harness plug from the regulator.

1. Insert the end of a short length of electrical wire to the RED connector slot of the regulator harness and the other end of the wire to the BLUE connector slot. This bypasses the regulator and tests the alternator and the harness.
2. Using your steel screwdriver, inspect for a magnetic field as described above.
3. With your voltmeter, check for voltage on the blue wire at the alternator. If voltage does not exist, the harness may be at fault. If voltage does exist at the harness, but no magnetism is present, the alternator is likely to be malfunctioning.
4. If a magnetic field is present. Both harness and alternator brushes and rotor appear to be working properly. If no magnetic field is present, proceed with the next test.

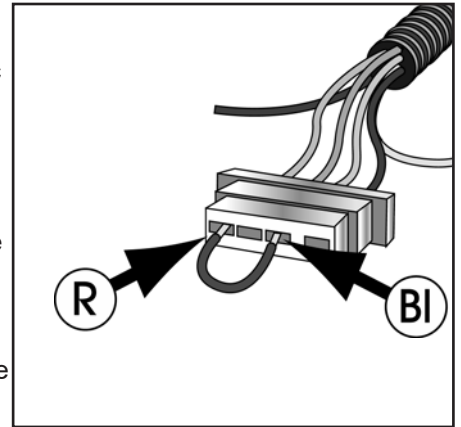

Testing the actual output of the alternator is known as "Full Field Testing". This can be accomplished by jumping a positive 12VDC current to the field terminal at the rear of the alternator. This test eliminates both the regulator and the harness, making it easier to isolate your investigation to the alternator.

**CAUTION:** Ensure that all voltage sensitive equipment is turned off prior to starting the engine. Voltage is

unregulated during this test and could damage sensitive electronics. DO NOT let the engine run any longer than necessary to detect charging. If the system is not charging, remove the alternator and have it inspected by a qualified alternator shop, or call Balmar for warranty evaluation. To test the alternator:

1. Clip a jumper wire to the positive post of the alternator, or on the battery side of the isolator (if an isolator is in use). Use a SHIELDED alligator clip for post attachment. Unintentional contact between the alligator clip and the alternator case could result in damage to your electrical system.
2. Disconnect the field wire from the rear of the alternator and attach the other end of the jumper wire to the alternator's Field terminal (F). **CAUTION:** Do not allow the wire to contact the case while it is attached to the positive post. The case may be grounded and severe damage could occur.
2. The regulator is now bypassed. When the ignition is engaged and the motor is started, the voltage should rise and charging current should be present.

3. The motor should be run long enough to determine that charging voltage is present. Unregulated voltage can rise quickly. Do not allow extended unregulated charging to occur without carefully monitoring voltage levels. If the alternator fails to generate voltage during field testing, a malfunction of the alternator is likely. Contact your local alternator repair shop or Balmar's technical service staff for recommendations.

## SMART READY® REGULATOR TEST

Six-Series and XT alternators require slightly different diagnosis to determine if the Smart Ready® internal regulator is functioning correctly. To test the internal regulator:

1. Disconnect the external regulator wiring harness from the alternator wiring plug containing the field and stator wires. Turn the ignition switch to the ON position.
2. Contact the positive probe of your test lamp on the FIELD terminal of the wiring plug. Connect the tester's negative probe to ground. If the internal regulator is functioning properly, the test light will illuminate.
3. If testing the operation of the internal regulator with a multi-meter, adjust the meter to read DC volts before placing probes at the field terminal and ground. If the regulator is working correctly, the meter will show approximately 3V DC.

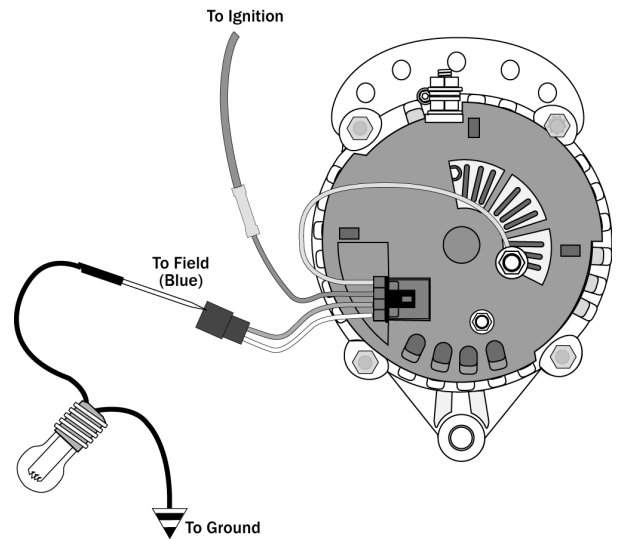

## CONCLUSION

If alternator and regulator tests indicate proper operation, further investigation into battery damage or wiring failure is recommended. If charging system performance continues to be compromised, we strongly advise that you seek the assistance of a certified marine electrical diagnostician. For additional assistance or recommendations, contact our Customer Service department at +1-360-435-6100.

NOTES







### **Balmar Limited Warranty**

Balmar's Limited Warranty covers defects in material or workmanship on new Balmar products generally for a period of two (2) years from the purchase date. Only consumers or dealers purchasing Balmar products from authorized Balmar retailers or resellers and installed by a qualified installer may obtain coverage under Balmar's Limited Warranty. Components with a manufacturing date greater than ten (10) years old are not covered under the Balmar Warranty, even if the purchase date has been within the past two (2) years. Purchase from unauthorized resellers, which may include some online entities, may not guarantee the purchaser will receive a newly manufactured component, and therefore does not guarantee Warranty coverage.

### **Warranty Resolution**

If Balmar authorizes a product to be returned to Balmar or an authorized service provider, Balmar will repair the product or replace it without charge with a functionally equivalent replacement product. Balmar may replace the product with a product that was previously in service or repaired, but re-tested to meet Balmar specifications. Balmar will pay to ship the replacement product to the purchaser. By sending the product for replacement, ownership of the original product will be transferred to Balmar. Labor charges at the consumer's site are not covered under this Warranty. Balmar warrants that repaired or replaced products shall be covered under the Balmar Warranty for the remainder of the original product warranty, or 90 days, whichever is greater.

### **Not Covered Under Warranty**

Balmar's Warranty does not cover any problem that is caused by (a) an accident, abuse, neglect, exposure to shock, electrostatic discharge, heat or humidity beyond the product's specifications, improper installation, inappropriate operation/misapplication, maintenance or modification, or (b) any misuse contrary to the instructions provided with the product, or (c) loss, or (d) malfunctions caused by other equipment, or (e) acts of God. Examples of conditions not warranted: cracked or broken cases, parts damaged by fire, water, freezing, lightning, collision, theft, explosion, rust, corrosion, or items damaged in route to Balmar for repair. Balmar's Warranty is void if a product is returned with removed, damaged or tampered labels or any other alterations (including removal of any component or external cover) to the product. Balmar's Warranty does not cover labor charges or any direct, consequential, or incidental damages. Costs related to recovery removal or installation are not recoverable under the Balmar Limited Warranty.

### **Applicable Laws**

Balmar's Warranty is governed by the laws of the State of Alabama, USA. The Balmar Warranty provides the purchaser specific legal rights, and you may also have other rights that vary from state to state. Balmar's Warranty does not affect any additional rights consumers have under laws in their jurisdictions governing the sale of consumer goods, including, without limitation, national laws implementing EC Directive 44/99/EC. Some states do not allow the exclusion of limitation of incidental or consequential damages, so the limitation or exclusions of Balmar's Warranty may not apply in certain jurisdictions.

### **Warranty Return Material Process**

1. **Contact Balmar Technical Support at +1 (360) 435-6100. Tech Support will review the troubleshooting steps with you to help determine if Balmar's product is defective. DO NOT return product to place of purchase.**
2. Go to [www.balmar.net](http://www.balmar.net) and download the RMA request.
3. Once complete, you will receive an RMA number, at which point you should complete the forms and send them with the product and the original receipt showing the date of purchase to Balmar at the address listed below. Please include the RMA number on the outside of the package.
4. Please send the product postage prepaid via a carrier that can track the package. Note: If you have a 9-Series Alternator to return, please ship it to our Marysville, WA location.

**Balmar LLC**  
**353 James Record Road SW**  
**Huntsville, AL 35824**  
**Attention: Warranty Returns RMA#**

**Balmar LLC**  
**15201 39th Ave. NE**  
**Marysville, WA 98271**  
**Attention: Warranty Returns RMA#**

Once Balmar receives the product, we will test the product to determine if the problem is due to a defect in the product. If, at the sole discretion of Balmar, the problem is determined to be a manufacturer defect, Balmar will repair the product or send a new product to replace the defective product.

Balmar will not provide Warranty coverage unless Warranty claims are made in compliance with all the terms listed here, and the specified return procedures are followed.

© 2020 Balmar LLC. Unauthorized reproduction of part or all of this manual is forbidden. All of the information contained in this manual is believed to be accurate as of publication. Balmar retains the right to make changes to any and all products without prior notice, and may not be held responsible for resulting inconsistencies in this manual. Installers are encouraged to visit the Balmar website for the latest product information and service bulletins.

Balmar archives a comprehensive library of instructional manuals for nearly all current and out-of-production products on its website: <http://www.balmar.net/operation-manuals/>